

KĄTY W OKRĘGU

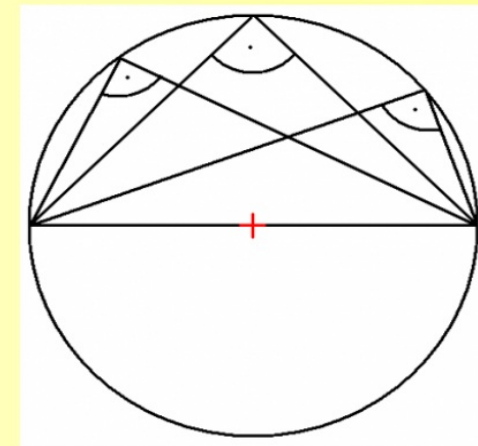

The background of the slide is a light gray color with a pattern of scattered black numbers (0-9) and faint, semi-transparent 'iStock by Getty Images' watermarks. The text is centered and written in a bold, red, sans-serif font.

**JAKIE
WZORY/ZALEŻNOŚCI
ZNAJDZIEMY
W TABLICACH
MATEMATYCZNYCH?**

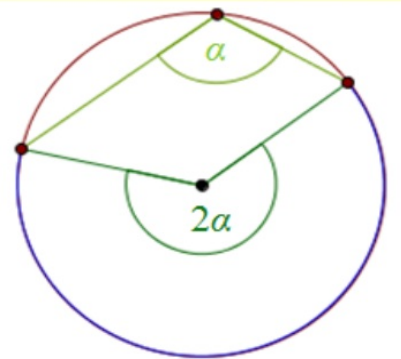
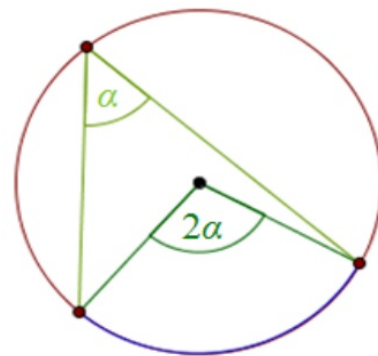
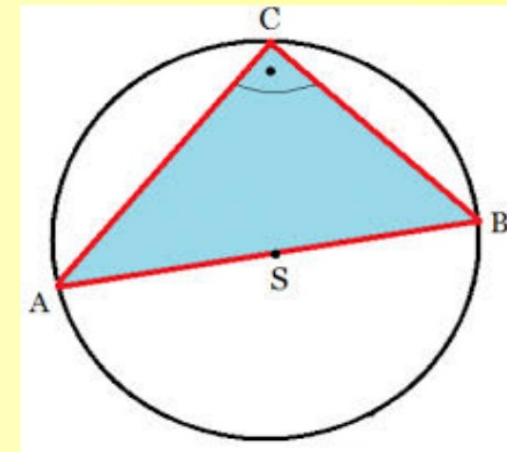
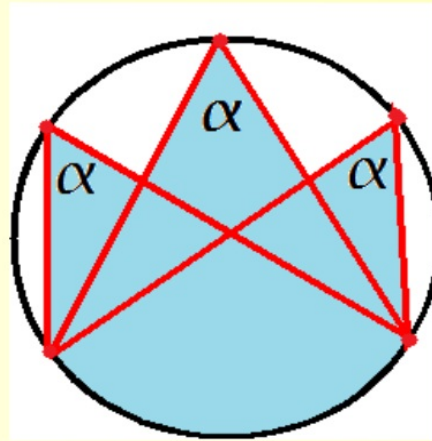
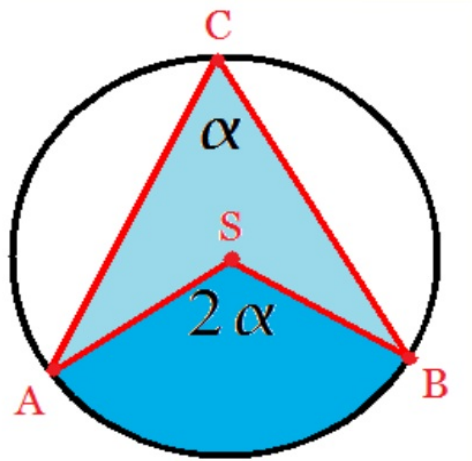
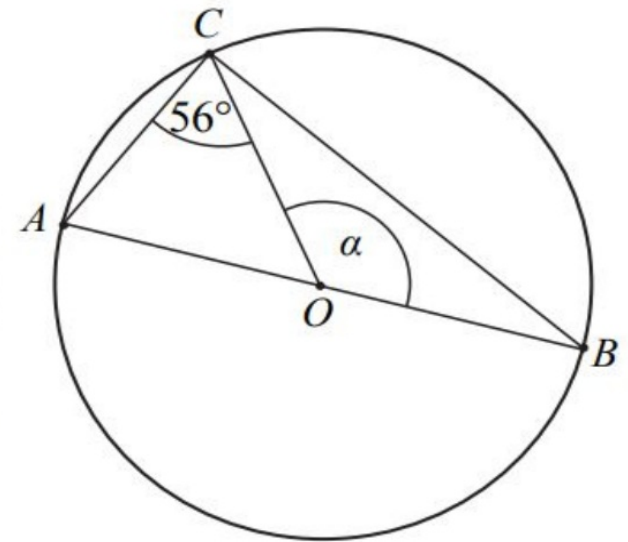
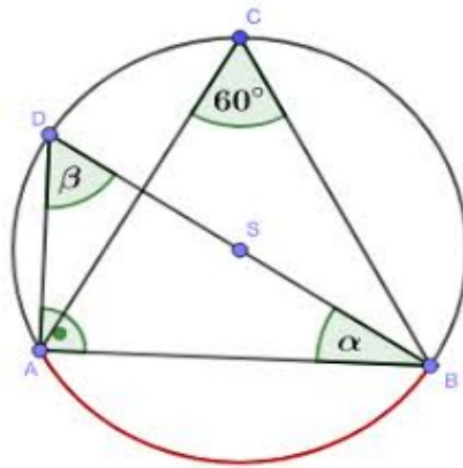
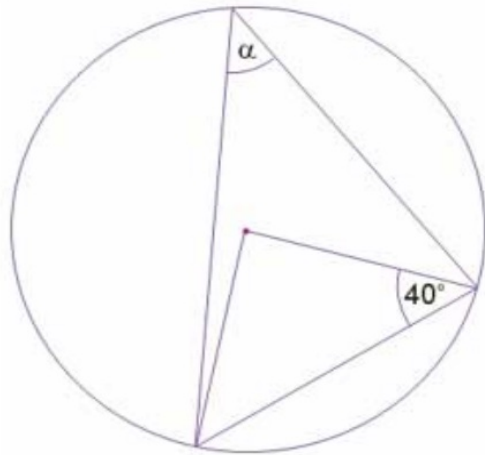
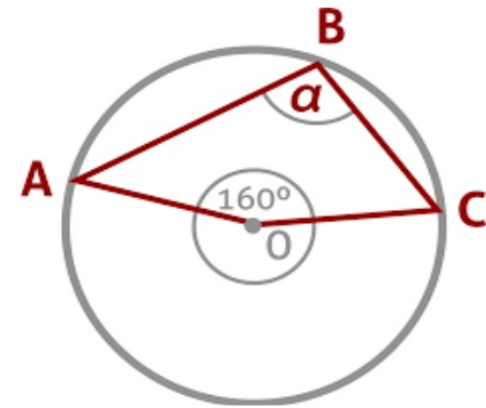
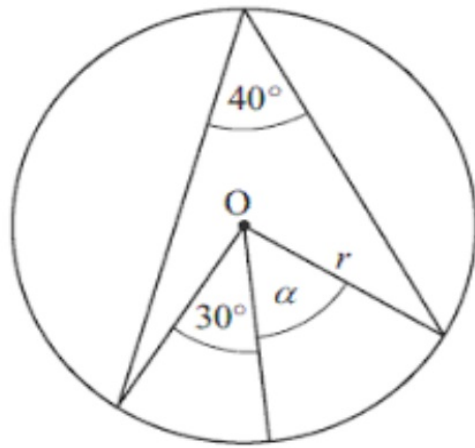
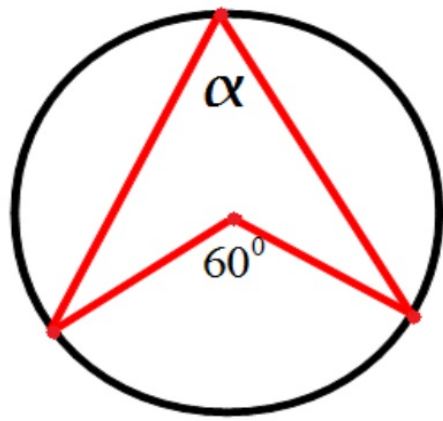

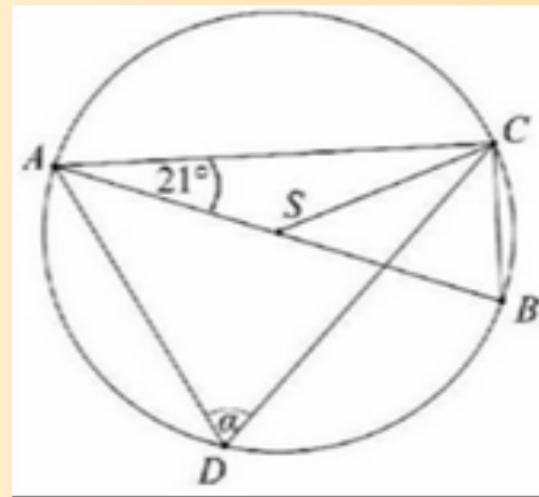
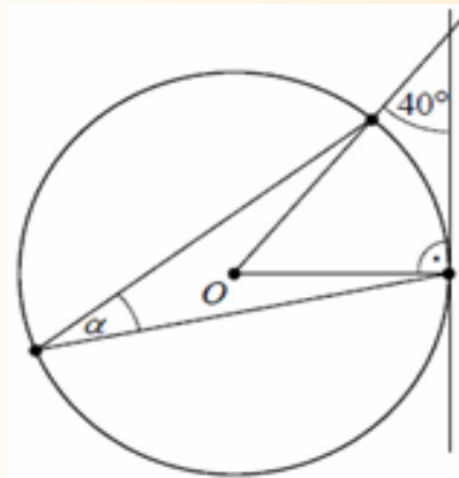
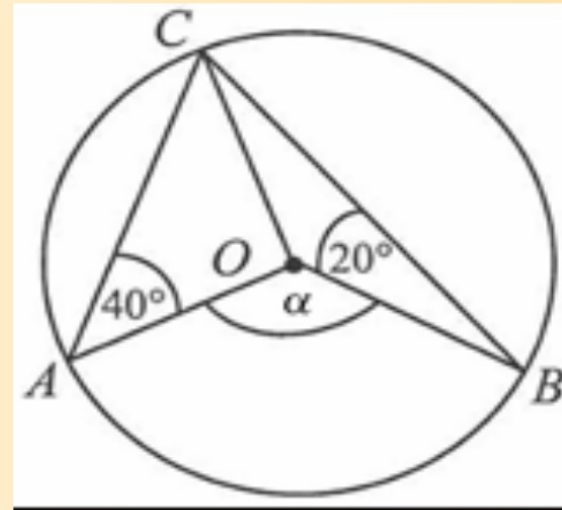
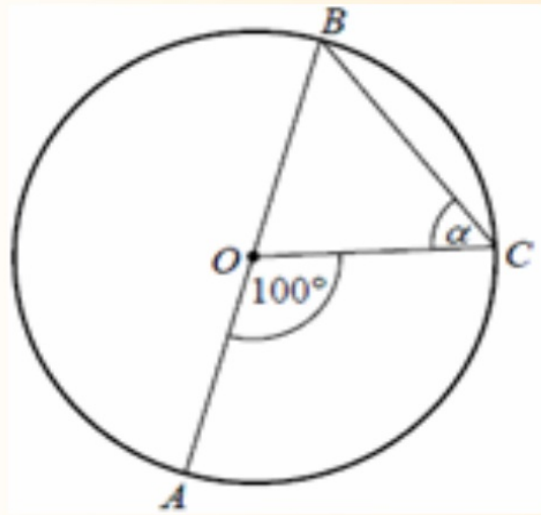

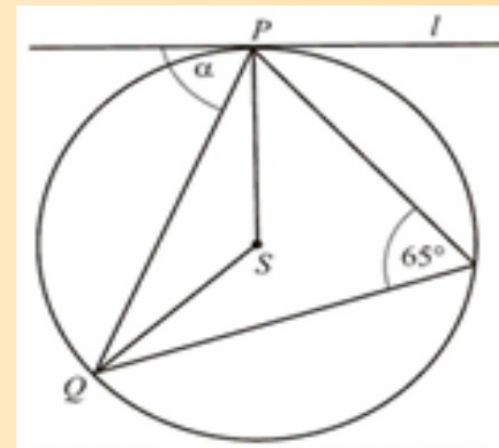
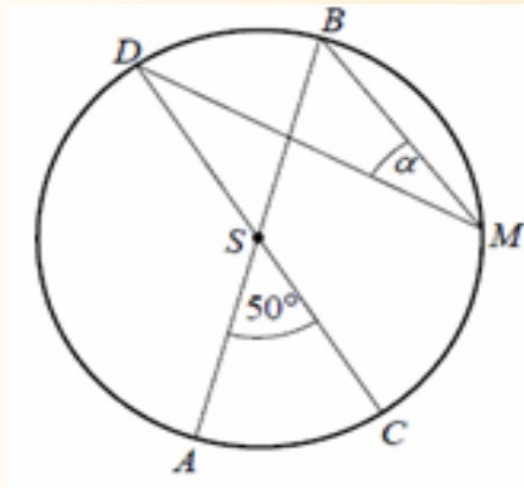
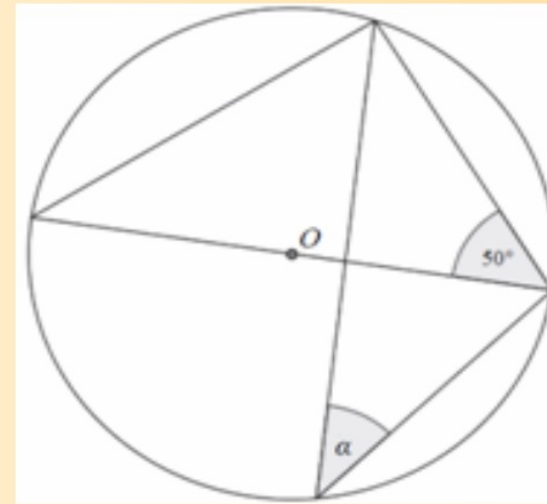
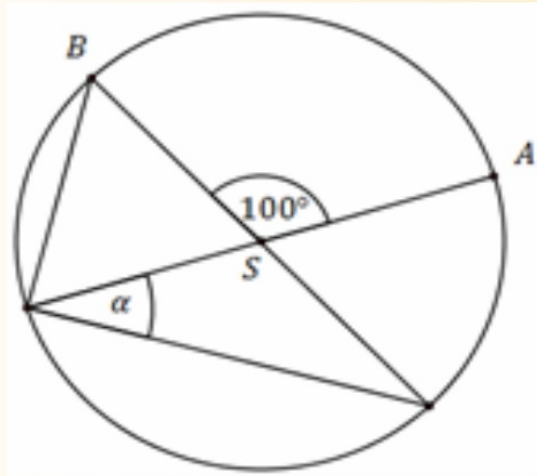

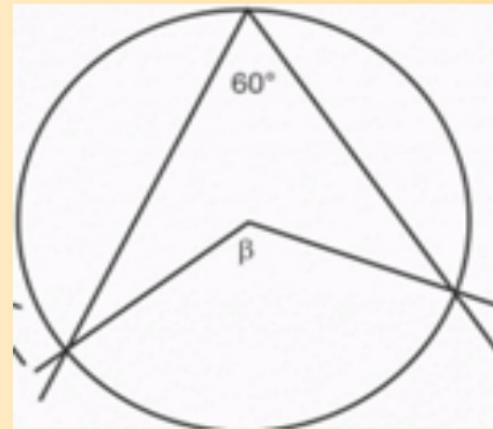
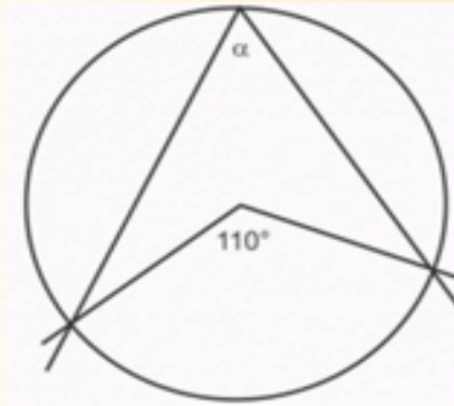
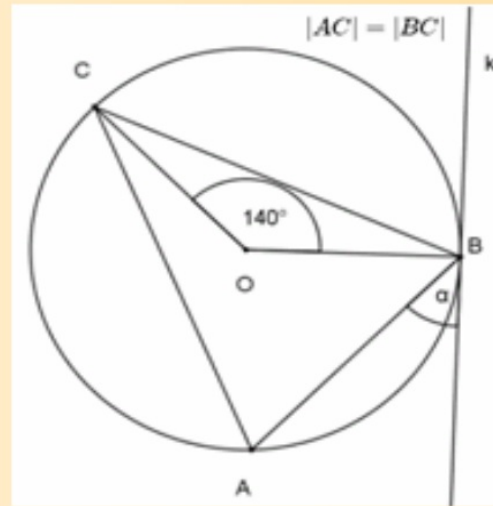
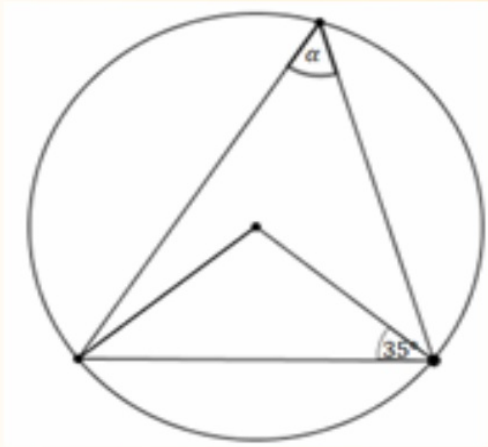

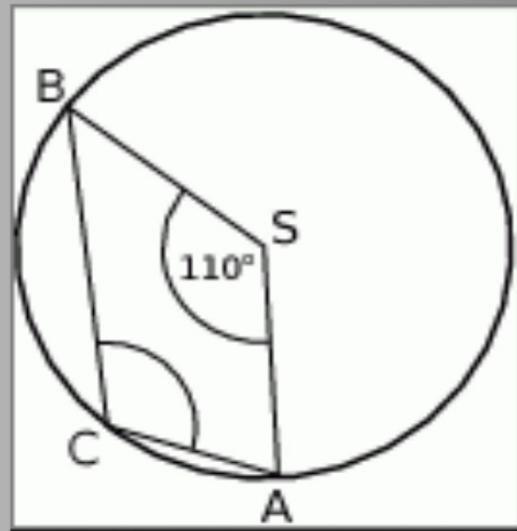
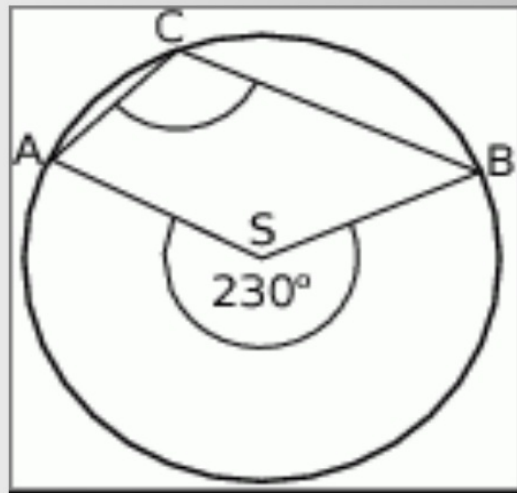
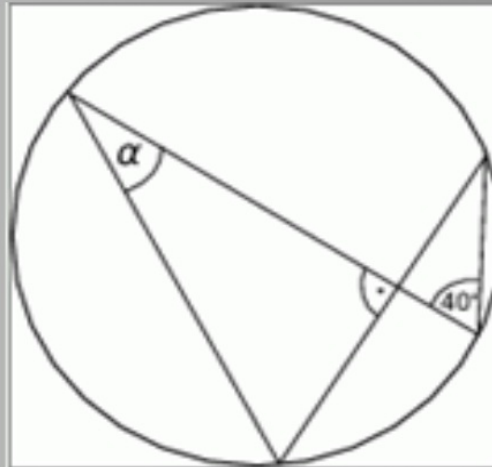
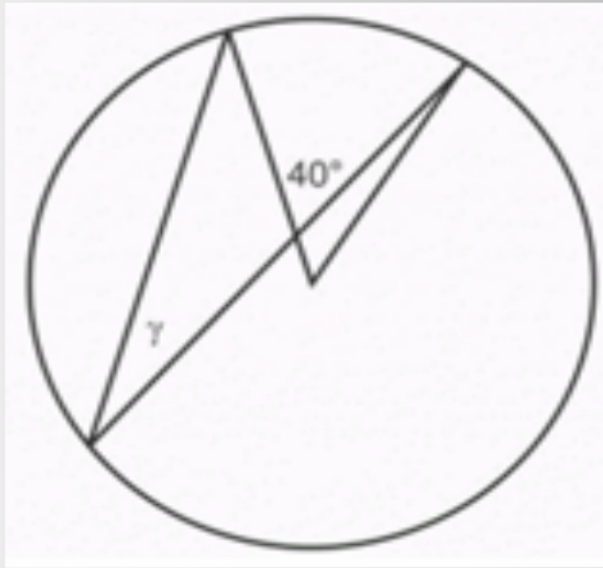

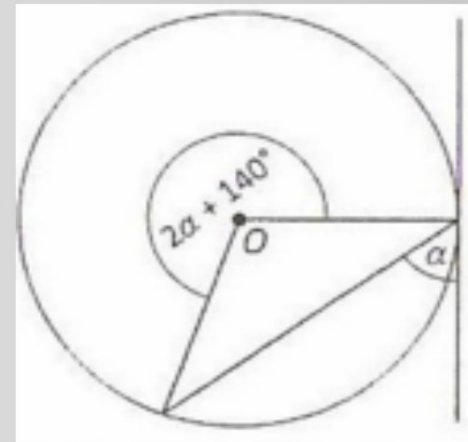
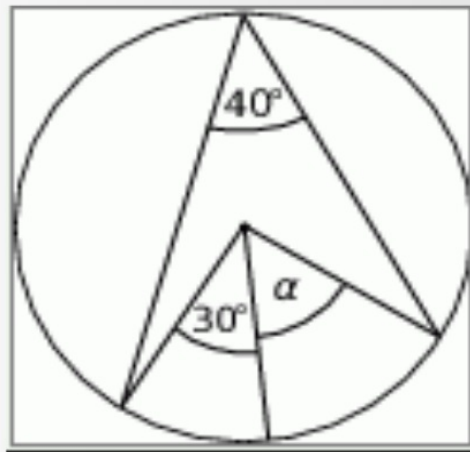
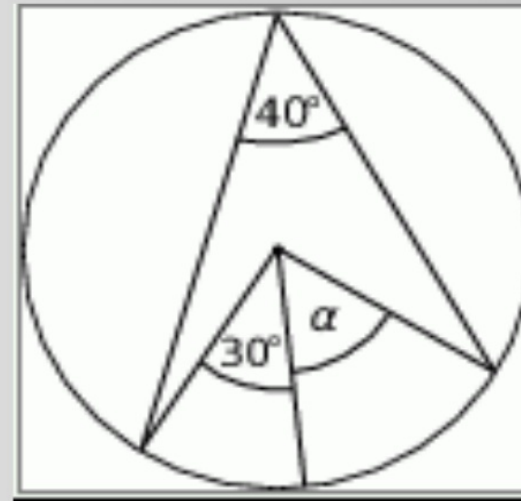
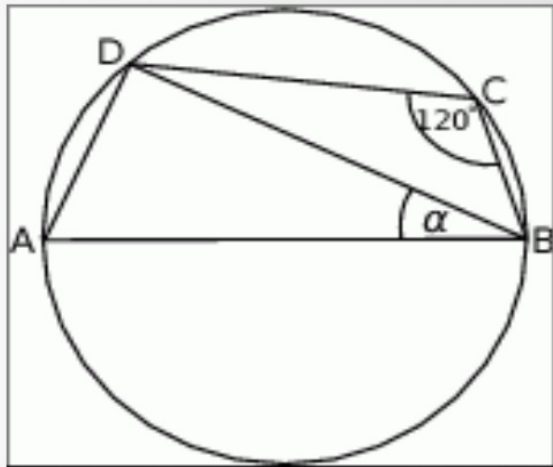

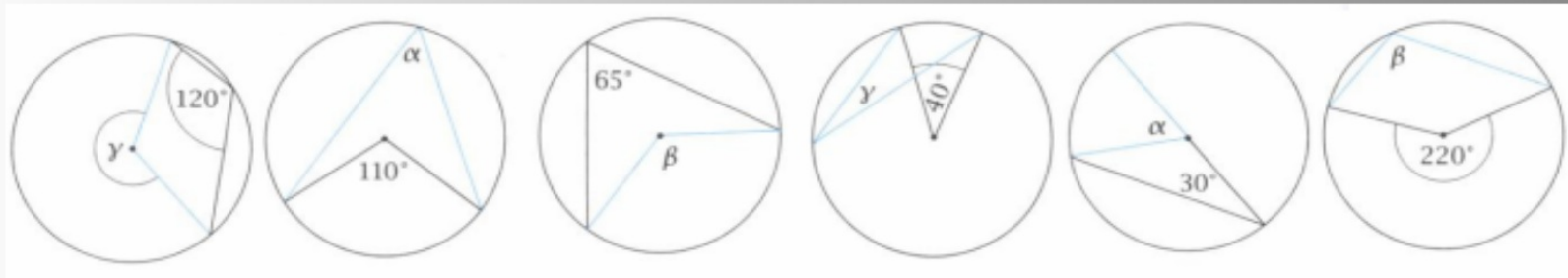

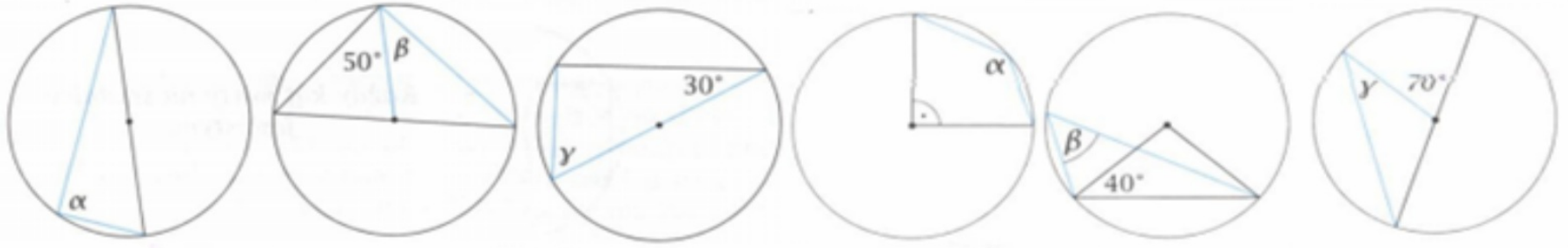

Ćwiczenie 5

Wyznacz miary kątów α , β i γ .

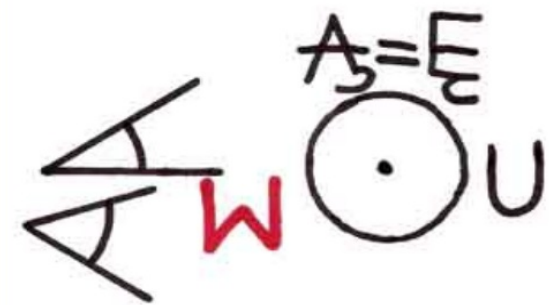
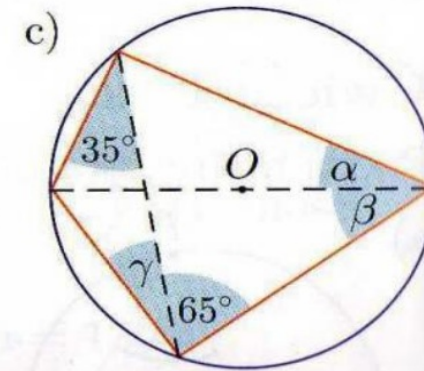
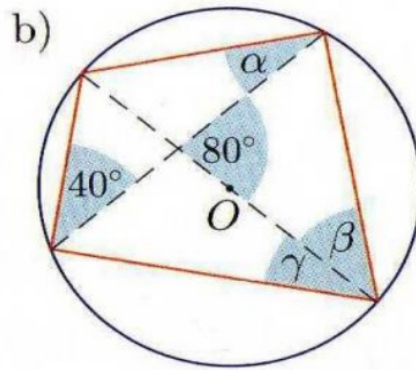
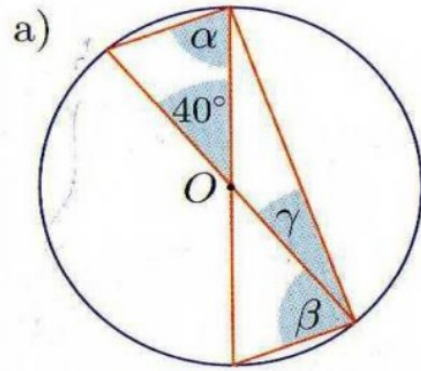

Ćwiczenie 4

Promień okręgu jest równy r . Wyznacz miary kątów α , β i γ .

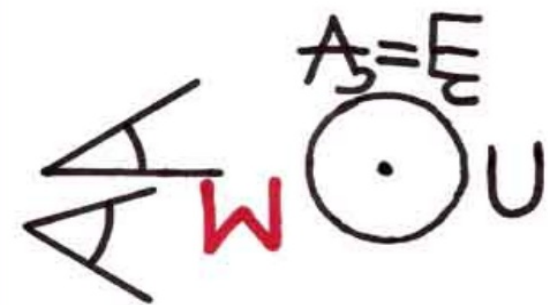
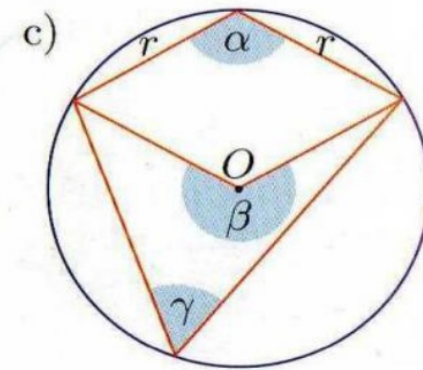
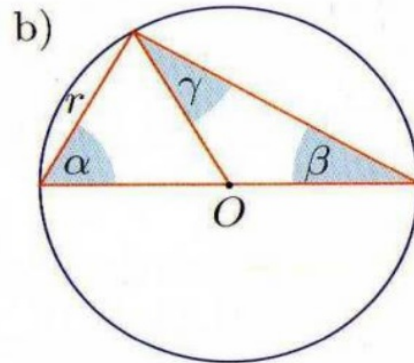
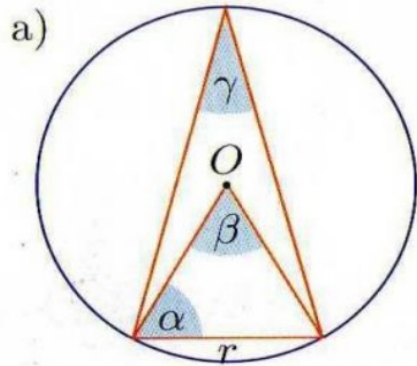

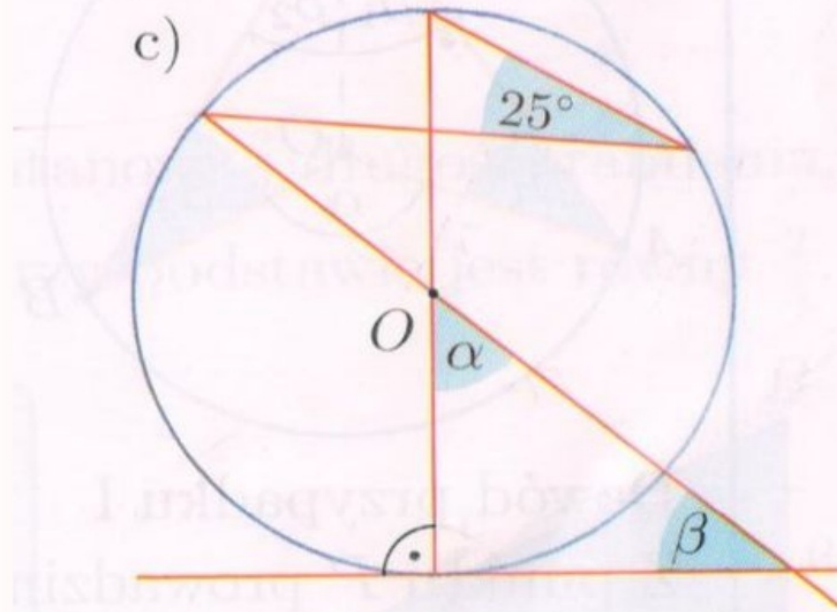

2. Wyznacz miary kątów α i β .

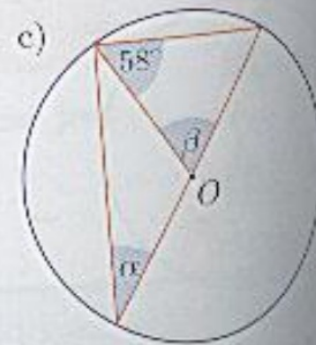
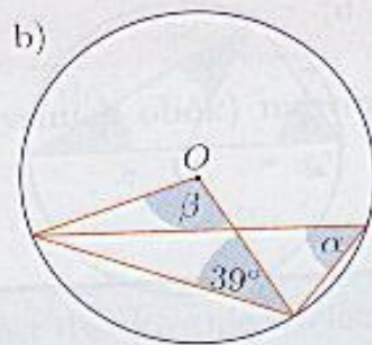
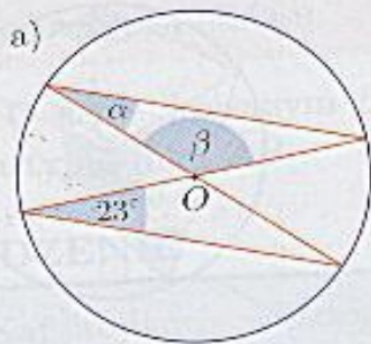

tworzą razem łuk co jest

